

PROFILES
areco

Udvidet klikfals sortiment med 4 nye profiler

Easy-Clickfals

- En økonomisk attraktiv og bæredygtig løsning

Made in Denmark



Easy-Clickfals - Profiler

Areco har hele 4 nye profiler som vil kunne inspirere til nye designs

1

EASY-CLICKFALS 500

Den velkendte klassiker, der holder år efter år. Med sit elegante design og holdbare kvalitet er det et oplagt valg for både nutidens og fremtidens arkitekter. 500-modellen er vores traditionelle, tidløse Easy-Clickfals, som passer til ethvert byggeri med sit elegante design.

2

EASY-CLICKFALS 500-426

En model, der bevarer det klassiske look, men nu med et 426 mm spejl i stålet. Den giver en mere rolig og stilren overflade. Perfekt til dem, der ønsker den traditionelle Clickfals æstetik med en forbedret visuel oplevelse designet holder sig til det forventede udseende som en Clickfals løsning.

3

EASY-CLICKFALS 500-164

Modellen leverer et ekstra stilrent look med en diskret opdeling, der minimerer synlige spor og samtidig holder det klassiske Clickfals-design. Stålfimmeret udjævnes, så du opnår et mere ensartet udseende – perfekt til dem, der søger en enkel, harmonisk flade.

4

EASY-CLICKFALS 500-MICRO

Dette er valget for dig, der ønsker den mest jævne og flimmerfri overflade. Med 500 Micro-modellen sikrer et gennemført look, der gør taget til det perfekte billede af en Clickfals. Denne model er så flimmerfri, at den også fås i 0,50 mm tykkelse, hvilket sikrer en let, men holdbar løsning med maksimal æstetik.

Easy-Clickfals - Detaljer

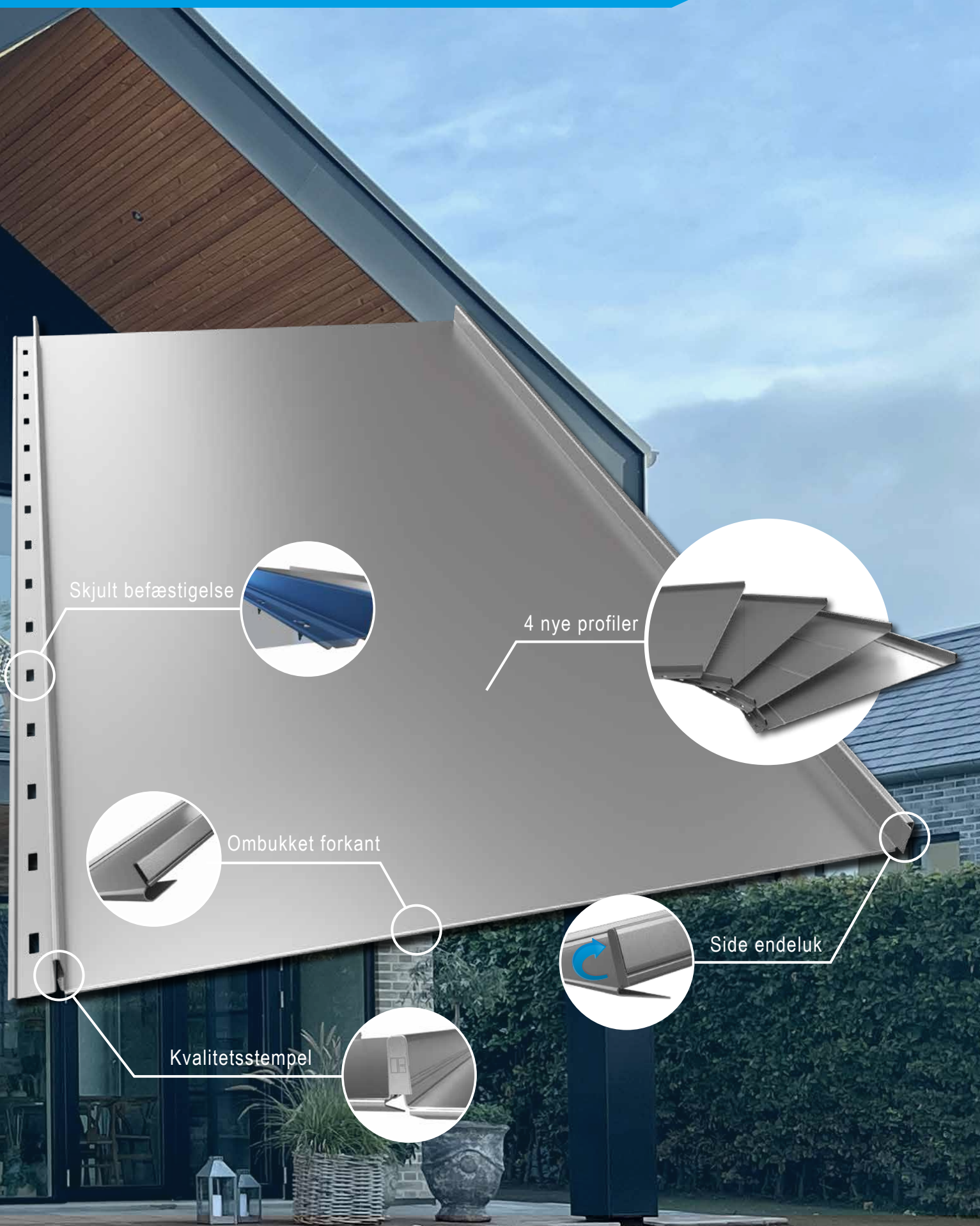

Easy-Clickfals - Projekter



Easy-Clickfals - Projekter



Easy-Clickfals 500 profiler

SIMON BULLINGER

- reducer CO²-tal med tyndpladestål på facader

Reducer 20% i stål forbrug med Easy-Clickfals profilen Micro som kan produceres i tykkelse 0,5 og kan beholde styrken ved brug af "micro" bølger

Easy-Clickfals

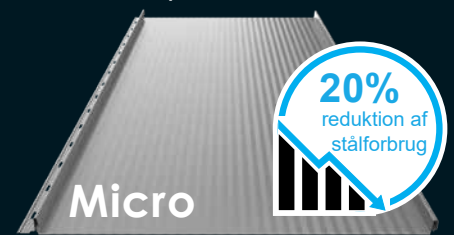

I jagten på et minimeret CO₂ aftryk skal man i materialevalget ikke kun skele til EPD'erne, men også til levetiden på produktet. Et materiale man formoder har et lavt CO₂ aftryk, kan overraske i LCA analysen, når materialernes forventede levetid tilføjes beregningen.

Easy-Clickfals
500

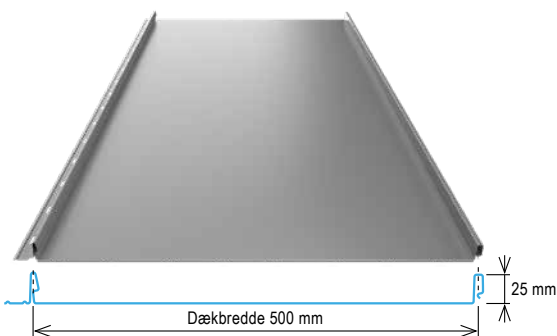

Easy-Clickfals
500-426

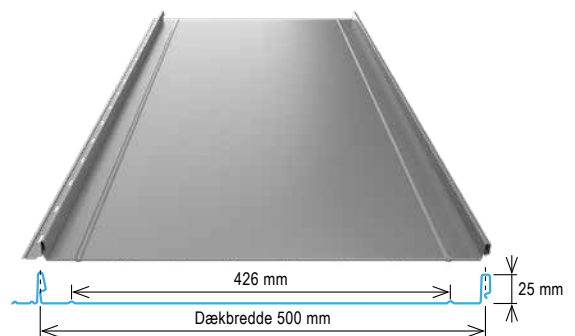

Easy-Clickfals
500-164

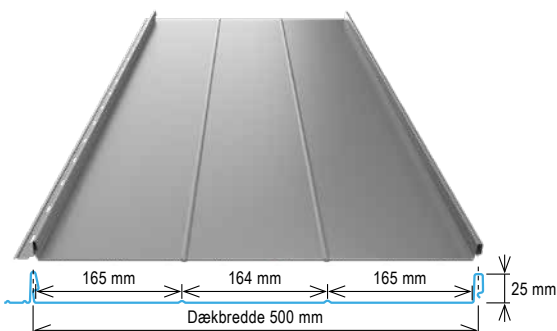

Easy-Clickfals
500-Micro

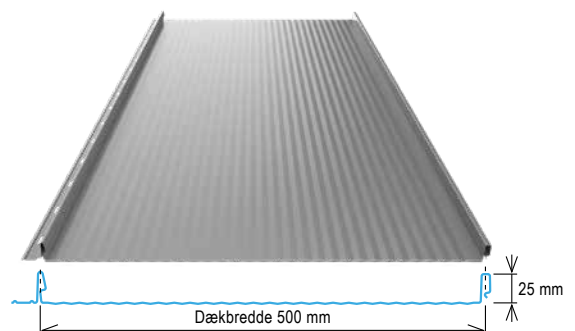

Easy-Clickfals 295 profiler



Easy-Clickfals
295

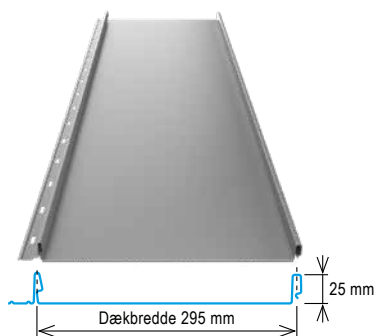

Easy-Clickfals
295-148

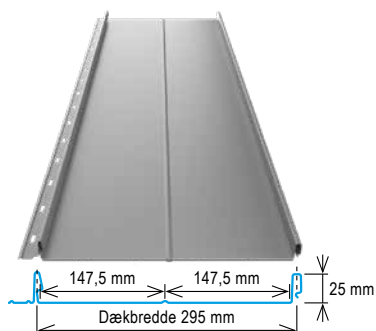

Easy-Clickfals
295-221

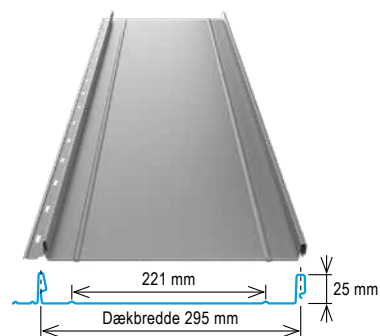

Easy-Clickfals
295-Micro

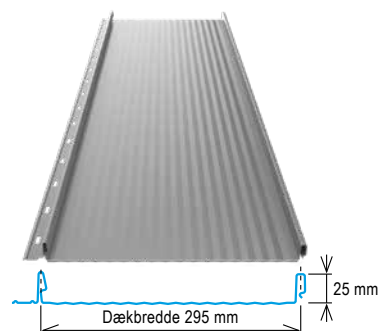

The Nordic Barnhouse



Vinder af
Tyndpladeprisen
2022
"Publikumsprisen"



Vinder af
Randers Kommunes
Arkitekturpris
2021

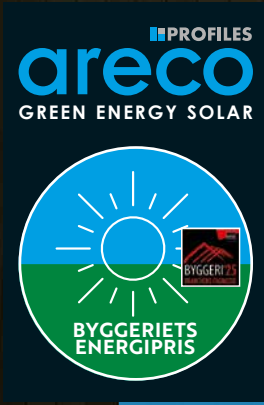

Vinder af "Byggeriets Energipris" 2025

Areco Profiles og Green Energy har skabt en solcelleløsning, der er specielt designet til at integreres med ståltage, herunder Easy-Clickfals ståltage og helt nyt til Pandplade-profil. Easy-Clickfals-profilen har brede spor og usynlige befæstelser, hvilket gør den velegnet til både moderne og klassisk arkitektur.

Solcellerne er designet til at ligge helt plant med taget uden at forstyrre de arkitektoniske linjer, hvilket gør dem æstetisk tiltalende. Stålets genanvendelighed og solcellernes lave CO2-aftryk understøtter en cirkulær økonomi i byggeriet.

Areco Green Energy Solar

Areco Easy-Clickfals tag kombineret med solceller

Areco Green Energy Solar er en arkitektonisk solcelleløsning, der integreres elegant med Easy-Clickflas ståltaget – helt uden befæstelser. Det er et komplet bygningsintegreret solcelleanlæg, hvor solcellerne er limet direkte på tagprofilen.

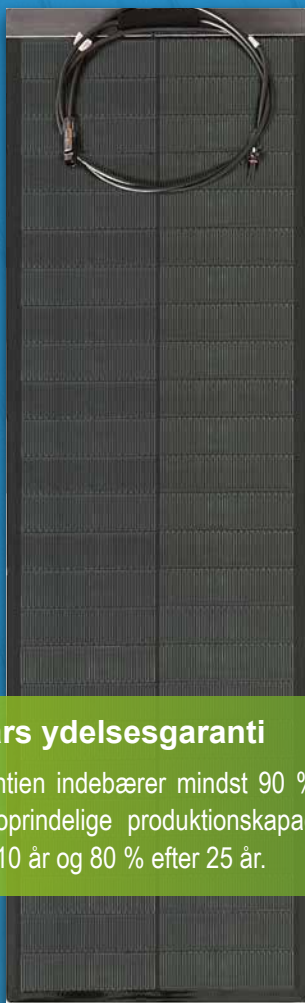

GIGS SOLAR PANEL

75W

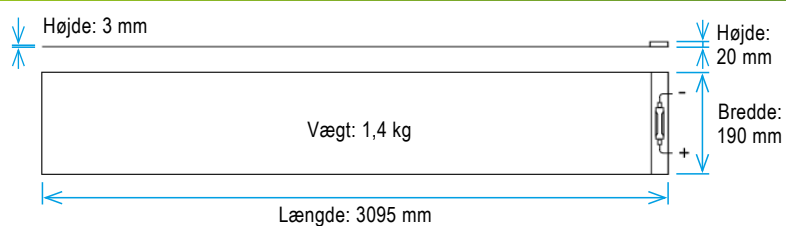

GIGS SOLAR PANEL

95W

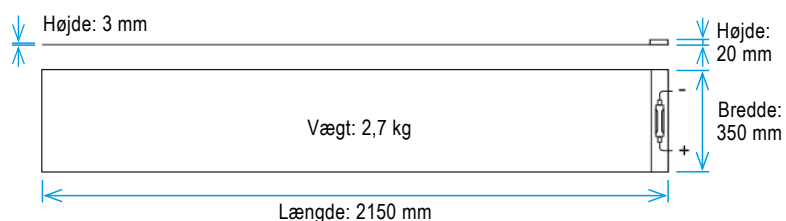

25 års ydelsesgaranti

Garantien indebærer mindst 90 % af den oprindelige produktionskapacitet efter 10 år og 80 % efter 25 år.

GIGS SOLAR PANEL

150W

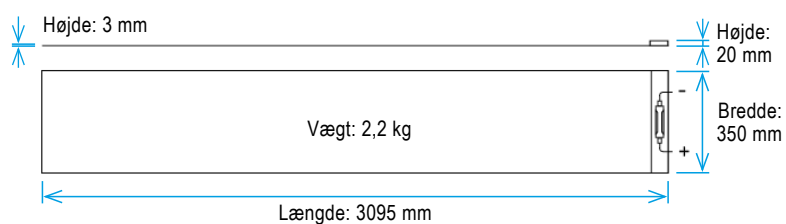

Easy-Clickfals

Dækkebredde [mm]	295	500		
Profilhøjde[mm]	25			
Min. pladelængde [mm]	1.000			
Maks. pladelængde [mm]	10.000			
Færdig endeombuk [mm]	25			
Minimum taghældning	8°			
Fals til endeluk (falseluk)	Ja			
Pladetykkelse [mm]	(0,50 - Micro) - 0,60			
Stålkvalitet	S280GD + Z275 g/m ²			
Overflade	Polyester (25 µm) PolyMax (30 µm) GreenCoat Pro BT mat (36 µm) GreenCoat Pural BT mat (36 µm)			
Profiler	500	500-426	500-164	500-Micro
	295	295-221	295-148	295-Micro
Vægt [kg/m ²]	ca. 6,0 kg/m ²			
Maks. lægteafstand	0,50 = 250 mm		0,60 = 300 mm	

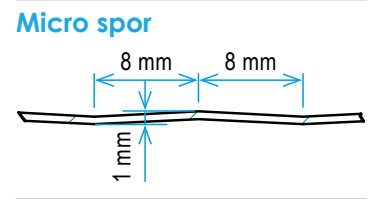
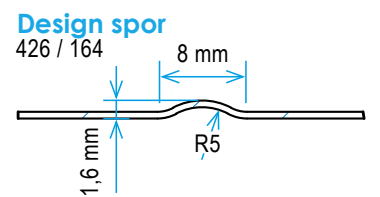
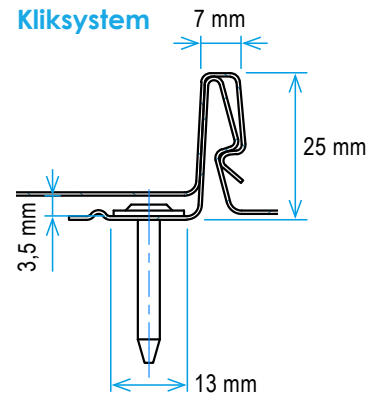

Endeluk

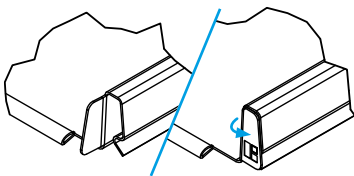

Ombuk

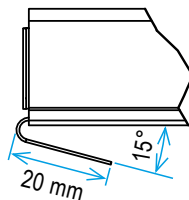

Skrue

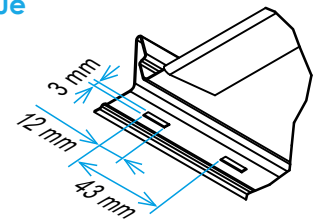

Easy-Clickfals 295

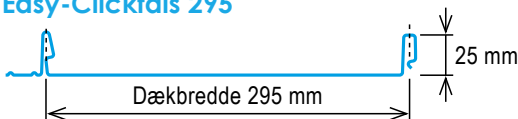

Easy-Clickfals 295-221

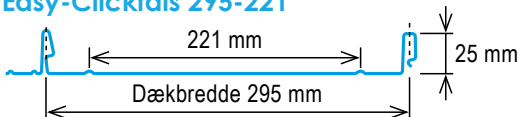

Easy-Clickfals 295-148

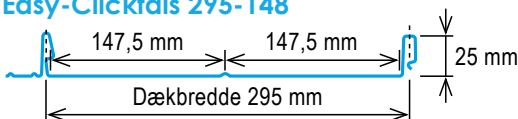

Easy-Clickfals 295-Micro

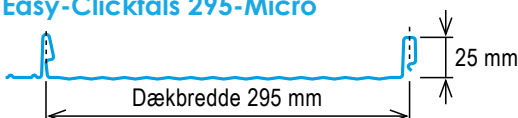

Easy-Clickfals 500

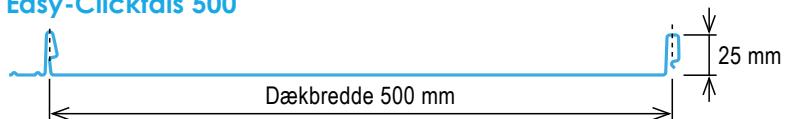

Easy-Clickfals 500-426

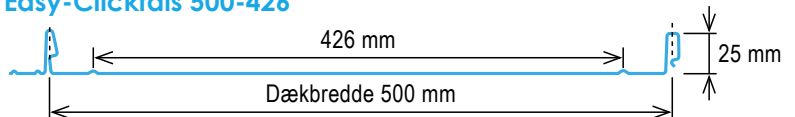

Easy-Clickfals 500-164

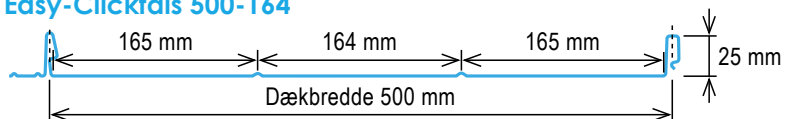

Easy-Clickfals 500-Micro

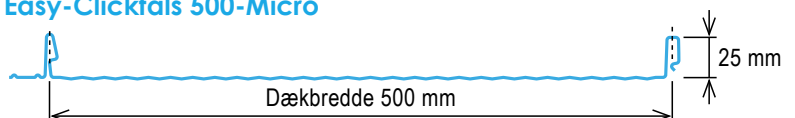

Farvekort

Polyester — 25 µm

Sort
AR9011

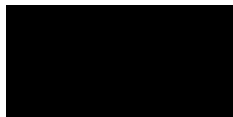

0,60

Silver
AR9006



0,60

Mørk silver
AR9007



0,60

Antracitgrå
AR7016



0,60

PolyMax MatGranit — 30 µm

Sort
AR9011

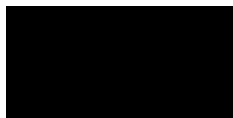

0,60

Mørk silver
AR9007



0,60 mat

Grafitgrå
AR7024



0,60

Perle kobber
AR8029



0,60

Chromoxid grøn
AR6020



0,60

Mahognibrun
AR8017



0,60

GreenCoat Pro BT (mat) — 36 µm

Sort
AR9011

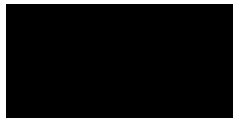

0,60

Silver
AR9006



0,60

Mørk silver
AR9007



0,60

Antracitgrå
AR7016



0,60

Tegl rød
AR8004



0,60

Mørkerød
AR3009



0,60

GreenCoat Pural BT (mat) — 50 µm

Sort
AR9011

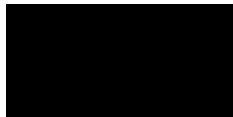

0,60

Antracitgrå
AR7016



0,60

Bringing steel to life

- since 1944 -

Areco Profiles A/S
Industriparken 22-24
DK - 9575 Terndrup
Tele: +45 98 33 64 00
Mail: info@areco.dk
Web: www.areco.dk

PROFILES
areco